

ACアダプター仕様書

直流安定化出力 Type

『トランス方式』

提出日

仕様書NO DK201105-0600

1 形式	DK060-R	安定化回路	有																																																				
2 外観	添付図面参照																																																						
3 特性	<p>◆ 定格事項</p> <table border="0"> <tr> <td>入力電圧</td> <td>AC</td> <td>100 V</td> <td></td> </tr> <tr> <td>周波数</td> <td></td> <td>50/60 Hz</td> <td></td> </tr> <tr> <td>消費電力</td> <td></td> <td>14 VA</td> <td></td> </tr> <tr> <td>出力電圧</td> <td>DC</td> <td>6 V± 10%</td> <td>(無負荷時)</td> </tr> <tr> <td>出力電圧</td> <td>DC</td> <td>6 V± 5%</td> <td>(定格負荷時)</td> </tr> <tr> <td>出力電流</td> <td></td> <td>600 mA</td> <td></td> </tr> </table> <p>◆ 絶縁 絶縁抵抗 50MΩ (入力, ケース各間 DC500V) 絶縁耐力 AC1200V 1分間 (1500V 1秒間)</p> <p>◆ 回路保護 温度ヒューズ(115°C/一次側)</p> <p>◆ 動作環境</p> <table border="0"> <tr> <td>入力電圧</td> <td>AC</td> <td>100 V</td> <td></td> </tr> <tr> <td>周波数</td> <td></td> <td>50/60 Hz</td> <td></td> </tr> <tr> <td>温度範囲</td> <td></td> <td>0°C ~ +40°C</td> <td></td> </tr> <tr> <td>湿度範囲</td> <td></td> <td>20 ~ 85% (非結露)</td> <td></td> </tr> </table> <p>◆ 規格 PSE </p> <p>◆ 入力方式 刃形式</p> <p>◆ 出力方式</p> <table border="0"> <tr> <td>出力コード式</td> <td>長さ</td> <td>1.8 m ±100mm</td> </tr> <tr> <td>出力プラグ</td> <td>外径</td> <td>5.5 φ</td> </tr> <tr> <td></td> <td>内径</td> <td>2.1 φ</td> </tr> <tr> <td></td> <td>長さ</td> <td>9.5 mm</td> </tr> </table>			入力電圧	AC	100 V		周波数		50/60 Hz		消費電力		14 VA		出力電圧	DC	6 V± 10%	(無負荷時)	出力電圧	DC	6 V± 5%	(定格負荷時)	出力電流		600 mA		入力電圧	AC	100 V		周波数		50/60 Hz		温度範囲		0°C ~ +40°C		湿度範囲		20 ~ 85% (非結露)		出力コード式	長さ	1.8 m ±100mm	出力プラグ	外径	5.5 φ		内径	2.1 φ		長さ	9.5 mm
入力電圧	AC	100 V																																																					
周波数		50/60 Hz																																																					
消費電力		14 VA																																																					
出力電圧	DC	6 V± 10%	(無負荷時)																																																				
出力電圧	DC	6 V± 5%	(定格負荷時)																																																				
出力電流		600 mA																																																					
入力電圧	AC	100 V																																																					
周波数		50/60 Hz																																																					
温度範囲		0°C ~ +40°C																																																					
湿度範囲		20 ~ 85% (非結露)																																																					
出力コード式	長さ	1.8 m ±100mm																																																					
出力プラグ	外径	5.5 φ																																																					
	内径	2.1 φ																																																					
	長さ	9.5 mm																																																					

★ プラグセンター

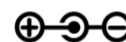

プラグ形状

ストレート



4 回路図

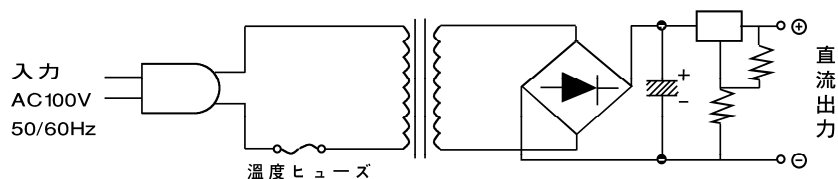

改定月日	内容	担当	改定月日	内容	担当	作成
2016/1/21	トラッキング対策	K.K				K.K

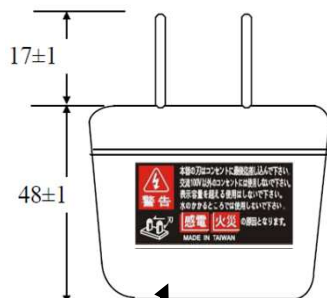
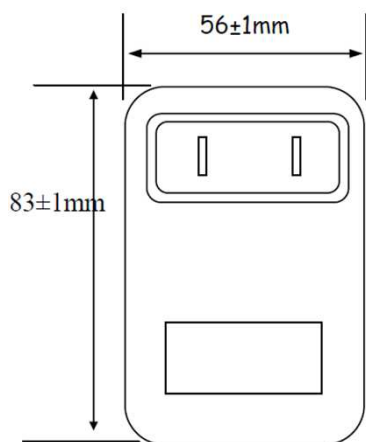
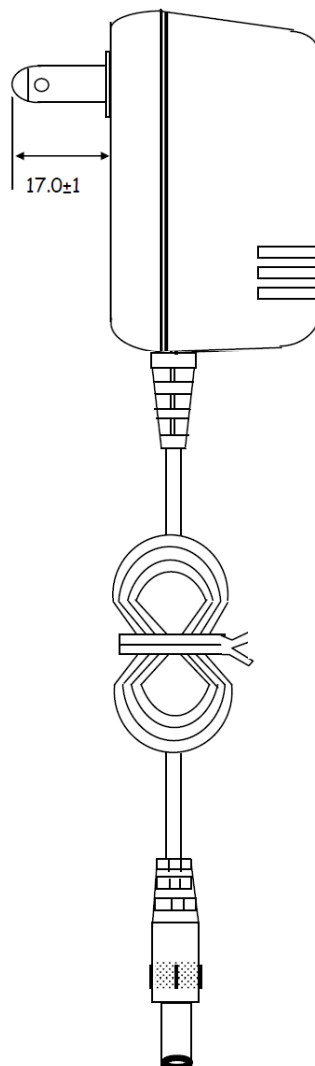
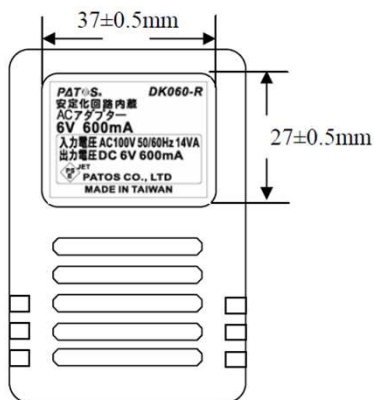

指定無き外形寸法精度 ±1mm

筐体材質: PC945

お客様

様経由

型式	DK060-R	図番	P-				
改定月日	内容	担当	改定月日	内容	担当	作成	
2016/1/21	トラッキング対策	K.K				K.K	